

Article number: 20343640M1050KR

Description: E+G levelling foot
GN 343.6-40-M10-50-KR

Measures

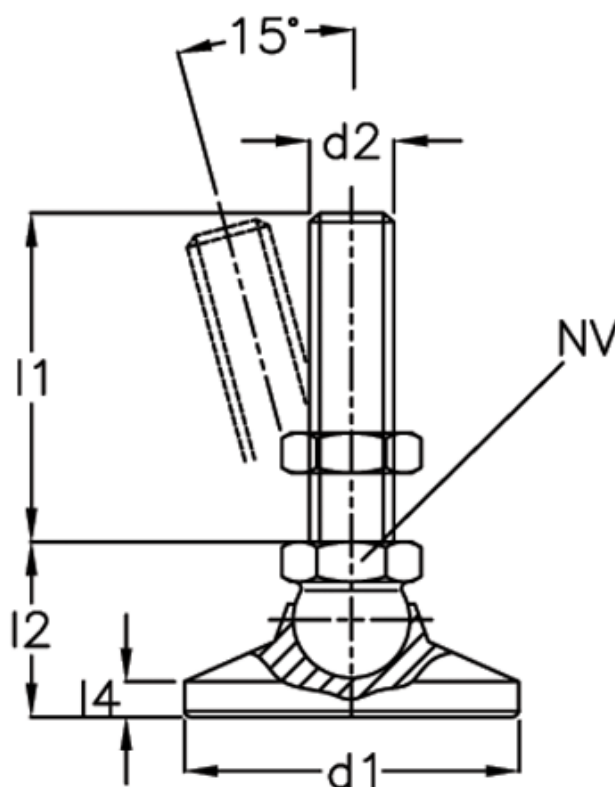

A/F	= 15
d1	= 40
d2	= 10
l1	= 50
l2	= -
l4	= -
Static load (N)	= 20
Weight in (g)	= 157